

# Wall mount Rack 9U 600\*450

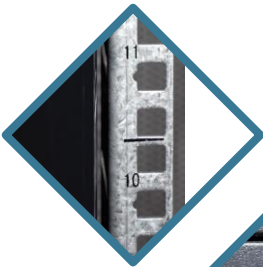

# Wall mount Rack 9U 600\*450

## Equipped with

Removable side walls  
Floor and roof plate with prepared ventilation openings  
4x 19-inch profile with height indication  
Doors to open both on the right side and on the left side  
Cable entry at the top and bottom  
Front door, rear door and side walls equipped with locks  
unassembled delivery

## Included

20 cage nut sets  
6 keys (2 per lock)

## Maximum load

80 kg

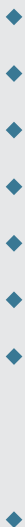

# Wall mount Rack 9U 600\*450

## SPECIFICATIONS

NAMES	QUANTITY	MATERIALS
Top Covers	1	1.0mm cold-rolled steel
Bottom plates	1	1.0mm cold-rolled steel
Frames	2	1.0mm cold-rolled steel
Front doors	1	5mm tempered glasses 1.2mm cold-rolled steel
Side panels	2	1.2mm cold-rolled steel
Horizontal brackets	4	1.2mm cold-rolled steel
L-shaped panels	2	1.2mm cold-rolled steel
Back panels	1	1.0mm cold-rolled steel
Wall hanging panels	1	1.2mm cold-rolled steel
Profile rails	4	1.5mm cold-rolled steel
Cage nuts	20	
Sockets with 6 outlet	1	
Fans	1	1.2mm cold-rolled steel
Shelves	1	1.2mm cold-rolled steel

Color	BLACK (RAL9005)- Powder Coating
-------	---------------------------------

CAPACITY (U)	6U
WIDTH	600
DEPTH	450
HEIGHT	370

## Logistics

Packing Dimensions (mm)	620*470*390
weight	19,5 / 21 [kg]
Use	inside, IP20

# Wall mount Rack 9U 600\*450

## DETAILED DRAWING

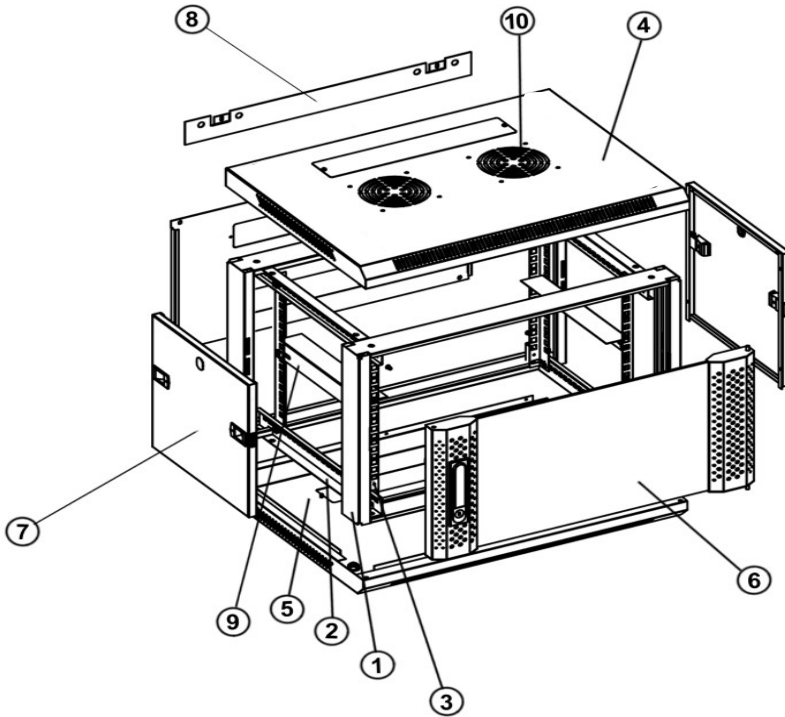

1	Frame
2	Horizontal crossbars
3	Vertical profile rails
4	Top plate with cable entry
5	Bottom plate
6	Glass door with lock
7	Removable side walls with lock
8	L-shaped bar
9	Ventilation holes including a cover plate on the inside of the server cabinet

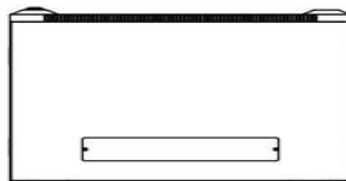

Bottom view

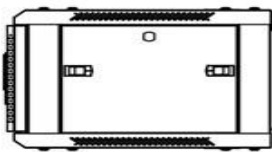

Side view



Front view

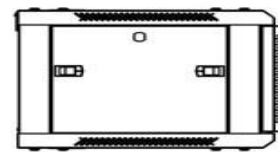

Side view

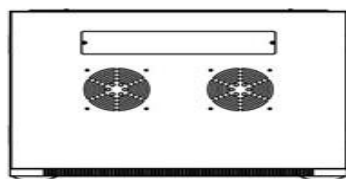

Top view

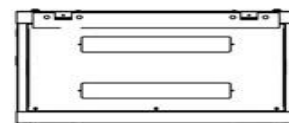

Back view



# Wall mount Rack 9U 600\*450

## Ordering Information

Part Number	MP.6409.9001
Product Description	SPECTRUM 9U RACK cabinet, wall mounted, 600x450

## Notes



**Spectrum Cables & Systems**  
**[www.spectrum-sys.uk](http://www.spectrum-sys.uk)**

A complete listing of the trademarks of Spectrum Cables & Systems is available at Spectrum Cables & Systems is ISO 9001 certified. © 2012 Spectrum Cables & Systems. All rights reserved

# Wall mount Rack 9U 600\*450